



Overview

The **ECC-VAVS and ECC-VAV series** are microprocessor-based variable air volume (VAV) controllers designed to control any variable air volume box. Each controller uses the LonTalk® communication protocol and is LONMARK certified, using the SCC-VAV profile #8502.

This series contains five models: ECC-VAVS, ECC-VAV, ECC-VVTS, ECC-VVT, and ECC-VAV-N. These models support various input types including resistance, voltage, and digital-based ones. Moreover, they provide digital, floating, pulse width modulation, and proportional control for valves, heating elements, fans, and lighting applications. In particular, the ECC-VAVS and ECC-VAV models have an on-board air flow sensor with a range of 0-1 inches of water column (250 Pascal), as well as a built-in brushless actuator for precise damper positioning for loads requiring up to 35 inch-pounds (4 Newton-meters) of torque.

All controller models work with the EC-Smart-Sensor-VAV, a communicating sensor that can be used for indoor temperature measurement, setpoint adjustment, occupancy state override, and system air balancing. In addition, all the controllers are Open-to-Wireless ready, and when paired with the Wireless Receiver, they work with a variety of wireless battery-less sensors and switches.

Each controller can be configured using the EC-Configure plug-in through any LNS®-based software, such as Distech Controls' Lonwatcher 3. Alternatively, controllers can also be configured using the EC-Configure wizard through EC-Net^{AX} which is powered by the Niagara^{AX} Framework®. Either way, a configuration interface exists that simplifies the setup of VAV and lighting applications through an intuitive menu-based user interface.

Applications

- Designed to meet the requirements of single duct VAV zone applications, including:
 - Cooling Only VAV Boxes
 - Cooling with Reheat VAV Boxes
 - Parallel Fan VAV Boxes
 - Series Fan VAV Boxes
- Improves energy efficiency when combined with:
 - Motion detectors to automatically adjust a zone's occupancy mode from standby to occupied when presence is detected
 - CO₂ sensors as part of a demand-controlled ventilation strategy that adjusts the amount of fresh air intake according to the number of building occupants
 - Light switches to control both lighting and a room's HVAC occupancy / standby mode setting
- Works with a wide range of wireless battery-less sensors

Features & Benefits

- Configurable using LNS-based EC-Configure plug-ins or Niagara^{AX}-based EC-Configure wizards, allowing you to work with your preferred network management platform
- Available with an optional Wireless Receiver that supports up to 6 wireless inputs, letting you create wire-free installations and use various wireless battery-less sensors and switches
- LONMARK SCC-VAV approved, guaranteeing interoperability with other manufacturers' LONMARK-approved controllers and interchangeability with ones that use the same profile
- Accurate on-board air flow sensor for precise air flow monitoring and control at low and high air flow rates, permitting you to design for maximum energy efficiency while maintaining an optimal comfort level
- Built-in actuator with a brushless motor and integrated position feedback system eliminates periodic damper re-initialization and ensures worry-free operation, providing increased occupant comfort and extended service life
- Highly accurate universal inputs support thermistors and resistance temperature detectors (RTDs) that range from 100 Ohms to 100 000 Ohms, giving you the freedom of using your preferred or engineer-specified sensors, in addition to any existing ones

Models in this Series



Model	ECC-VAVS	ECC-VAV	ECC-VVTS	ECC-VVT	ECC-VAV-N
Points	7-Point VAV	12-Point VAV	6-Point VVT	11-Point VVT	11-Point VAV
Universal inputs	2	4	2	4	4
Ability to use spare inputs	■	■	■	■	■
Built-in flow sensor (0-1 in. W.C.)	■	■			■
Wireless inputs ¹	4	6	4	6	6
Digital (triac) outputs	2	4	2	4	4
Digital (0 – 10VDC) LED occupancy output	1	0	1	0	0
Universal outputs	0	2	0	2	2
Network outputs (using NVOs)	2	6	2	6	6
Ability to use spare outputs	■	■	■	■	■
Built-in Actuator	■	■	■	■	
Product Number	CDIC-VASX-02	CDIC-VAXX-00	CDIC-VTSX-02	CDIC-VTXX-00	CDIC-VANX-00

1. Available when an optional Wireless Receiver is connected to the controller.

Recommended Applications

Model	ECC-VAVS	ECC-VAV	ECC-VVTS	ECC-VVT	ECC-VAV-N
Cooling Only VAV Box	■		■	■	
Cooling w/Reheat VAV Box	■		■	■	
Cooling w/Reheat VAV Box & Perimeter Heating		■		■	
Parallel Fan VAV Box		■			
Series Fan VAV Box		■			
Large Damper VAV Box Requiring More Than 35 in-lb (4 Nm) Actuator Torque					■
Existing Damper Actuator					■
Room Pressurization		■			

Open-to-Wireless Wireless Receiver – Optional



Open-to-Wireless



To reduce the cost of installation, and minimize the impact on existing partition walls, the Wireless Receiver enables every controller in this series to communicate with a line of wireless battery-less room sensors and switches.

Wireless Receiver (315) - Receiver for EnOcean® 315MHz wireless-enabled sensors and switches

Wireless Receiver (868) - Receiver for EnOcean 868.3MHz wireless-enabled sensors and switches

Note that controllers have one wireless port to support a single Wireless Receiver.

For more information about the EnOcean technology and Open-to-Wireless, refer to the Open-to-Wireless Solution Guide. For more information about the Wireless Receiver module, refer to the Wireless Receiver Datasheet. These documents can be found on our web site at www.distech-controls.com.

Supported Platforms



EC-Net^{AX}

EC-Net^{AX} is a web-enabled multi-protocol integration solution powered by the Niagara^{AX} Framework, establishing a fully Internet-enabled, distributed architecture for real-time access, automation and control of devices. EC-Net^{AX}'s open framework creates a common development and management environment for integration of LONWORKS[®], BACnet[®] and other protocols. Regardless of manufacturer and protocol, the EC-Net^{AX} system provides a unified modeling of diverse systems and data, providing one common platform for development, management and enterprise applications.



LNS[®] TURBO Edition

LONWORKS Network Services (LNS)

LNS[®] is a client-server platform that allows multiple users, running different LNS-compatible applications, to access a common source for directory, installation, management, monitoring and control services for the network system being managed. Distech Controls' Lonwatcher is an example of a LNS-based network management tool that can use Plug-Ins to configure and monitor controllers and devices in the control system.

EC-Net^{AX} Wizards and LNS Plug-Ins

EC-Configure EC-Net^{AX} Wizards

Designed for use with EC-Net^{AX} (powered by the Niagara^{AX} Framework), the EC-Configure EC-Net^{AX} Wizards can be used to easily configure a device's parameters including inputs, outputs, fan and valve settings, heating and cooling setpoints, amongst others. Moreover, these wizards can be used to enable and configure additional built-in features such as morning warm-up, load shedding, frost protection and slave operation mode.

EC-Configure LNS Plug-in

Similar to an EC-Configure EC-Net^{AX} Wizard, the EC-Configure LNS Plug-in is a user-friendly configuration interface, which is accessible through any LNS[®]-based software, such as Distech Controls' Lonwatcher 3.

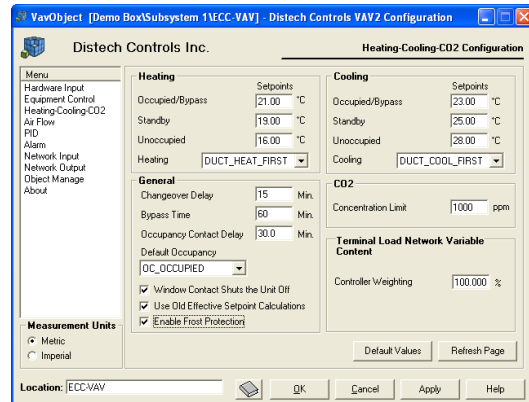

EC-Monitor LNS Plug-in

The monitoring plug-in is a graphical user interface that monitors all device parameters including inputs, outputs, alarms and device status. There is no more need to create any graphics pages and as it can be launched from any GUI that supports plug-in applications, graphics dynamically adapt themselves to the configuration of the device as well as the real time values being monitored.

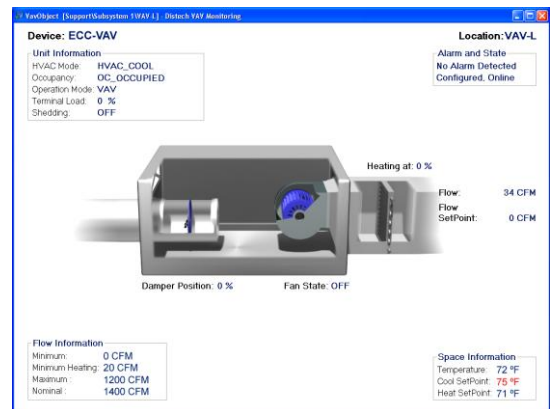

Complementary Products

Temperature Sensors

Supported Smart-Sensors



- EC-Smart-Sensor-VAV:
- Communicating sensor with 2-line LCD
 - Setpoint adjustment
 - Occupancy override
 - Indoor and outdoor air temperature display
 - VAV balancing

Allure EC-Sensor

Line of discrete sensors



- | | |
|---------------|--|
| EC-Sensor | Room temperature sensor with communication jack |
| EC-Sensor-O | Room temperature sensor with occupancy override button and communication jack |
| EC-Sensor-S | Room temperature sensor with setpoint adjustment and communication jack |
| EC-Sensor-SO | Room temperature sensor with setpoint adjustment, occupancy override button, and communication jack |
| EC-Sensor-SOF | Room temperature sensor with setpoint adjustment, occupancy override button, fan speed selection, and communication jack |

Open-to-Wireless Sensors and Switches (requires Wireless Receiver)

Allure Wireless Battery-less ECW-Sensor

Line of wireless, battery-less sensors. Available in EnOcean 315MHz and 868.3MHz versions.



- | | |
|----------------|--|
| ECW-Sensor | Room temperature sensor |
| ECW-Sensor-O | Room temperature sensor with occupancy override button |
| ECW-Sensor-S | Room temperature sensor with setpoint adjustment |
| ECW-Sensor-SO | Room temperature sensor with setpoint adjustment and occupancy override button |
| ECW-Sensor-SOF | Room temperature sensor with setpoint adjustment, occupancy override button, and fan speed selection |

Wireless EnOcean Sensors and Switches



- | | |
|--------|---|
| 41-580 | Wireless solar-cell powered motion detector. Available at 868.3MHz. |
|--------|---|



- | | |
|--|--|
| 2-channel Light Switch
4-channel Light Switch | 2-/4-channel wireless light switches (European models). Available at 315MHz or 868.3MHz. |
|--|--|



- | | |
|-------------------|--|
| PTM265
PTM265D | 2-/4-channel wireless light switches (North American models). Available at 315MHz or 868.3MHz. |
|-------------------|--|

For a complete list of the Open-to-Wireless EnOcean sensors and switches that are compatible with the controllers in this series, refer to the Open-to-Wireless Solution Guide which can be found on our web site at www.distech-controls.com.

Other



- | | |
|----------------------|---|
| Terminal Block Cover | Cover designed to conceal the wire terminals. Required to meet local safety regulations in certain jurisdictions. |
|----------------------|---|

For more information on these or other Distech Controls products please refer to our web site at www.distech-controls.com or contact sales@distech-controls.com.

Controller Dimensions

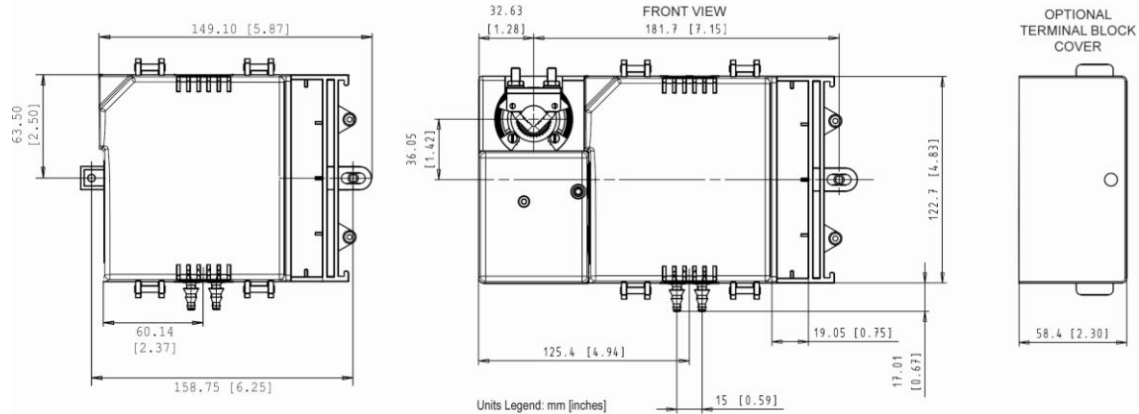

Product Specifications

Power

Voltage	24VAC; $\pm 15\%$; 50/60Hz; Class 2
Protection	3.0A user-replaceable fuse for triac outputs when using the internal power supply
Typical Consumption	
- ECC-VAVS and ECC-VVTS	12VA; triac outputs (1 valve @ 4VA) & 1 output with 20mA load @ 12VDC
- Other models	18VA; triac outputs (2 valves @ 4VA) & 2 outputs with 20mA load @ 12VDC
Maximum Consumption	
- ECC-VAVS and ECC-VVTS	40VA - if internal power supply is used
- Other models	70VA - if internal power supply is used

Interoperability

Communication Channel	LonTalk protocol
LONMARK Interoperability Guidelines	TP/FT-10; 78Kbps
LONMARK Functional Profile	Version 3.4
	SCC – VAV #8502

Hardware

Processor	Neuron [®] 3150; 8 bits; 10MHZ
Memory	Non-volatile Flash 64K (APB applications)

Environmental

Operating Temperature	0°C to 50°C; 32°F to 122°F
Storage Temperature	-20°C to 50°C; -4°F to 122°F
Relative Humidity	0 to 90% Non-condensing

Enclosure

Material	FR/ABS
Color	Black & blue casing & grey connectors
Dimensions (with Screws)	
- ECC-VAV-N	4.8" x 5.9" x 2.5" (122.7mm x 149.1mm x 63.0mm)
- Other models	4.8" x 8.4" x 2.5" (122.7mm x 214.3mm x 63.0mm)
Shipping Weight	
- ECC-VAV-N	0.92lbs (0.42kg)
- Other models	2.30lbs (1.05kg)

Integrated Damper Actuator

Motor	Belimo LMZS-H brushless DC motor
Torque	35 in-lb, 4 Nm
Degrees of Rotation	95° adjustable
Fits Shaft Diameter	5/16 to 3/4"; 8.5 to 18.2mm

Inputs

Input Types	Universal; software configurable
-Voltage	0-10VDC
-Current	4-20mA with 249Ω external resistor (wired in parallel)
-Digital	Dry contact
-Pulse	Dry contact; 500ms minimum ON/OFF
-Resistor	
<i>Thermistor</i>	10KΩ Type 2, 3 (10KΩ @ 25°C; 77°F) Range: -40°C to 150°C; -40°F to 302°F
<i>Platinum</i>	Pt1000 (1KΩ @ 0°C; 32°F) Range: -40°C to 150°C; -40°F to 302°F Pt100 (100Ω @ 0°C; 32°F) Range: -40°C to 135°C; -40°F to 275°F
<i>Potentiometer</i>	Translation table configurable on several points
Input Resolution	16-bit analog / digital converter
Differential Pressure	Range: 0 to 250 Pa (0 to 1.0 in. W.C.) Resolution: 0.000162 milli-in. W.C. Accuracy: $\pm 3\%$ full scale

Outputs

Digital	24 VAC Triac, digital (on/off), PWM, or floating; - 0.5A continuous - PWM control: adjustable period from 2 seconds to 15 minutes - Floating control: requires two consecutive outputs - Min pulse on/off: 500msec. - Adjustable drive time period External or internal power supply (jumper selectable)
Digital LED occupancy output	0-10VDC dedicated output for occupancy sensor LED. Max. 20mA
Universal	0-10VDC, digital 0-12VDC (on/off), floating or PWM - PWM control: adjustable period from 2 seconds to 15 minutes - Floating control: requires two consecutive outputs - Min pulse on/off: 500msec. - Adjustable drive time period - 20mA max. @ 12VDC - Minimum load resistance 600Ω
Output Resolution	10-bit digital / analog converter

Product Specifications (continued)

Wireless Receiver^{1,3}

Communication	EnOcean wireless standard
Number of wireless inputs ²	
- ECC-VAVS and ECC-VVTS	4
- Other models	6
Supported Wireless Receivers	Wireless Receiver (315) Wireless Receiver (868)
Cable	Telephone cord
- Connector	4P4C modular jack
- Length	6.5ft; 2m

Electromagnetic Compatibility

CE -Emission	EN61000-6-3: 2007; Generic standards for residential, commercial and light-industrial environments
-Immunity	EN61000-6-1: 2007; Generic standards for residential, commercial and light-industrial environments
FCC	This device complies with FCC rules part 15, subpart B, class B



EC-Smart-Sensors³

Models Supported	EC-Smart-Sensor-VAV
Power and Communication	2-wire
Number of sensors supported	1



Agency Approvals

UL Listed (CDN & US) Material ⁴	UL916 Energy management equipment UL94-5VA
--	---



Communication Protocols and Standards



- Available when an optional external Wireless Receiver is connected to the controller. Refer to the Open-to-Wireless Solution Guide for a list of supported EnOcean wireless modules.
- Some wireless sensors may use more than one wireless input from the controller.
- An EC-Smart-Sensor and Wireless Receiver cannot be used at the same time. However, an EC-Smart-Sensor can be temporarily connected to a controller in wireless mode to perform VAV airflow balancing.
- All materials and manufacturing processes comply with the RoHS directive  and are marked according to the Waste Electrical and Electronic Equipment (WEEE) directive .

Product Warranty & Total Quality Commitment

All Distech Controls product lines are built to meet rigorous quality standards and carry a two-year warranty. Distech Controls is an ISO 9001 registered company.

Functional Profile (ECC-VAVS and ECC-VVTS)

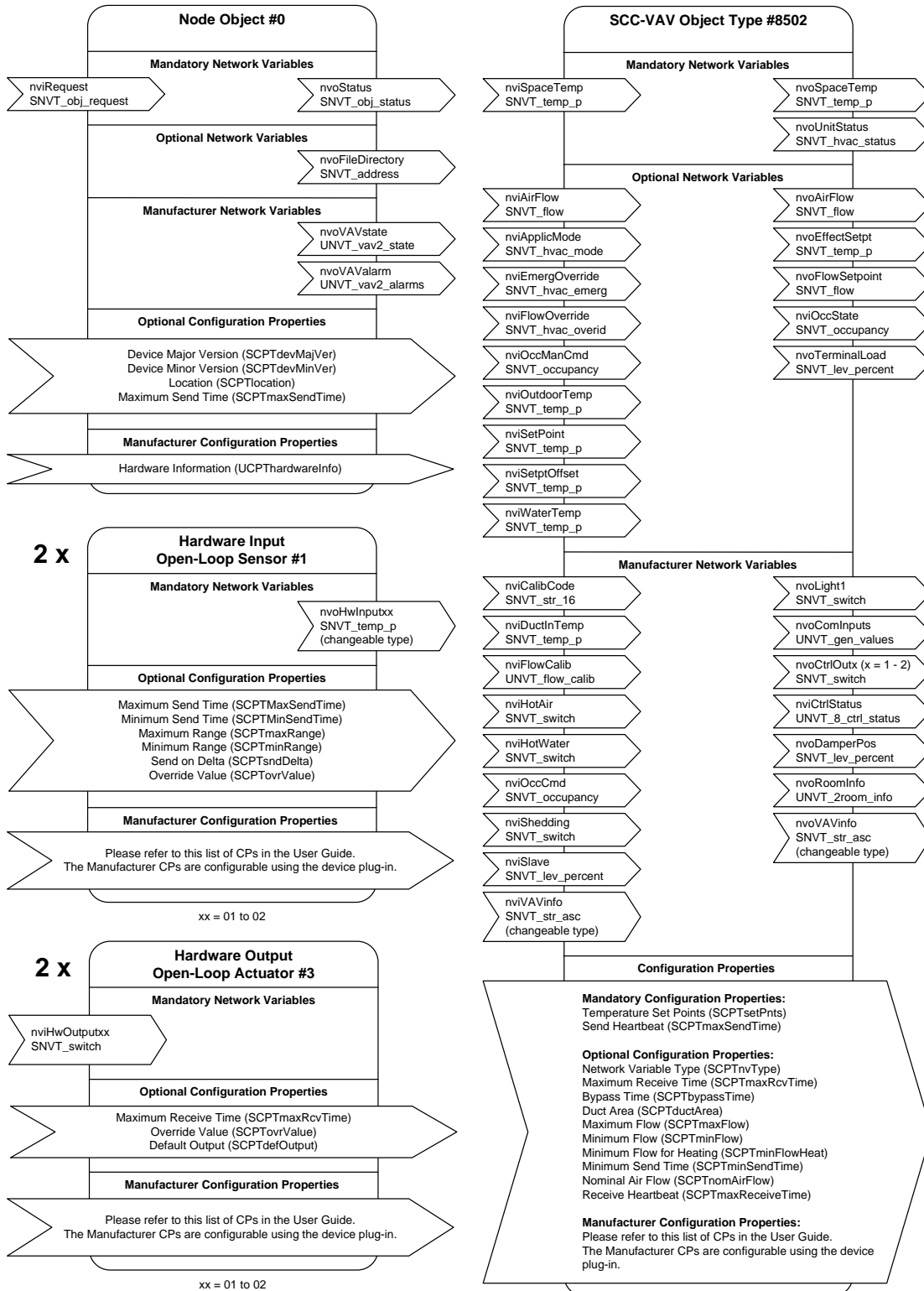

Functional Profile (ECC-VAV, ECC-VVT, and ECC-VAV-N)

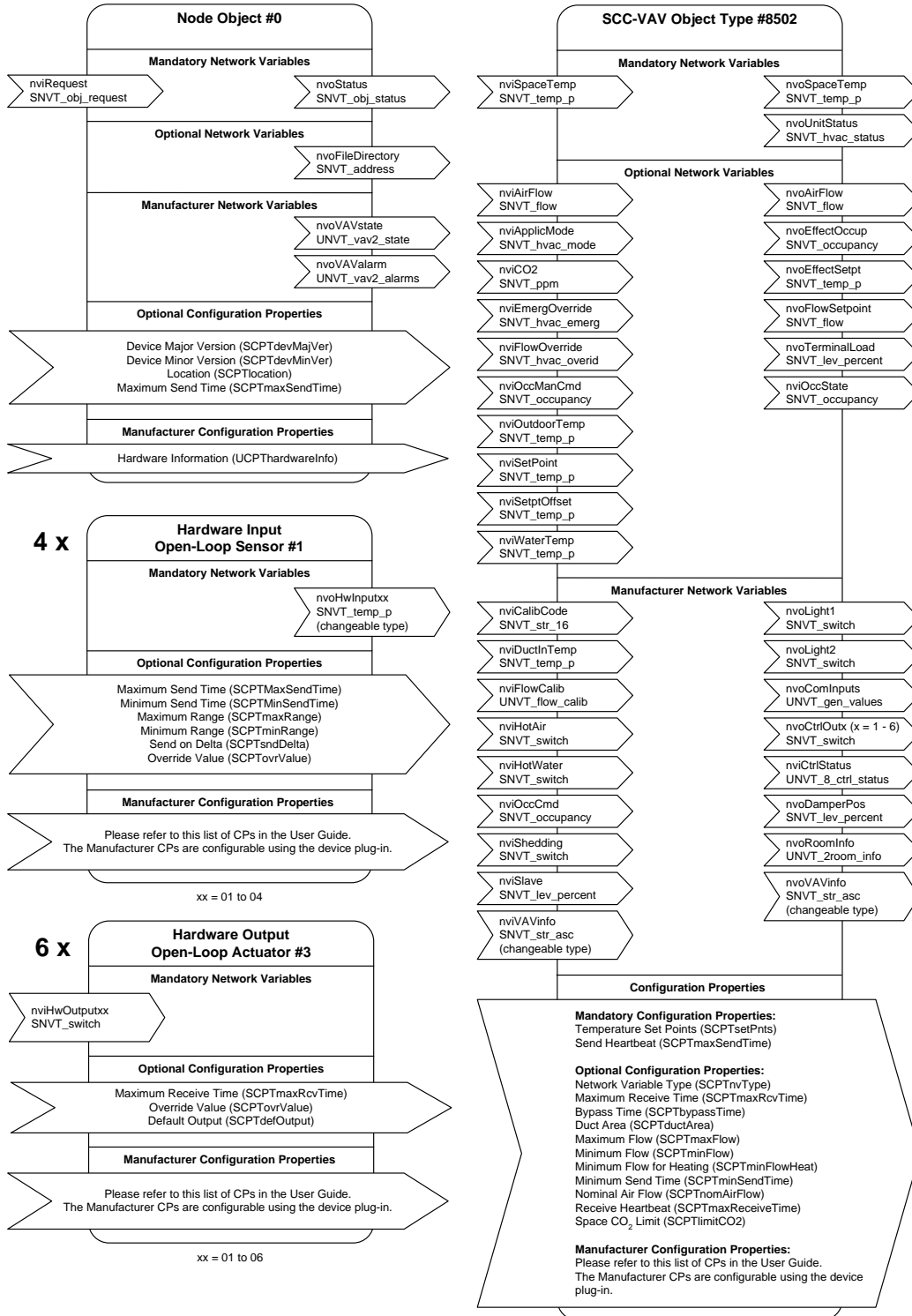

Specifications subject to change without notice.

Distech Controls and the Distech Controls logo are trademarks of Distech Controls Inc.; LON, LONWORKS, LONMARK, LonTalk, and LNS are registered trademarks of Echelon Corporation; Niagara^{AX} Framework is a registered trademark of Tridium, Inc.; BACnet is a registered trademark of ASHRAE; EnOcean is a registered trademark of EnOcean GmbH. All other trademarks are property of their respective owners.



05DI-DSCVAVX-40

ECC-VAVS and ECC-VAV
Series

www.distech-controls.com