

# SR65 AKF Series

## Wireless Air-duct Temperature Sensors



<p><b>Applications</b></p>	
<ul style="list-style-type: none"> <li>– Wireless and battery-less air-duct sensors for temperature control.</li> </ul>	
<p><b>Features</b></p>	
<ul style="list-style-type: none"> <li>– Integrated 868.3 MHz transmitter (transmissions conform to the EnOcean standard).</li> <li>– Solar-powered. No battery required and sensor can be recharged by daylight or artificial light.</li> <li>– Minimum illumination (artificial or daylight) of 200 lx for 3-4 hours daily will fully recharge sensor's energy cell.</li> <li>– Eliminate expenses for wiring plans, wire and conduit installation, electrician fees and other associated labor costs.</li> <li>– Eliminate placement errors (simply correct by moving sensor(s) to better location).</li> <li>– Optional battery option available for installations where light is not available (such as a duct).</li> <li>– Integrated temperature sensor.</li> <li>– Temperature update every 100 seconds with change of 1.6 °C or more.</li> <li>– Various temperature sensor lengths.</li> </ul>	<div style="text-align: center;">  <p><b>SR65 AKF</b></p> </div> <p>The SR65 AKF series are wireless and battery-less air-duct sensors for temperature control.</p> <p>These SR65 AKF series communicate with wireless-enabled controllers via radio telegrams in accordance with the EnOcean standard. All SR65 AKF models possess an integrated temperature sensor. All models are powered by solar energy, providing a maintenance-free operation.</p>

**Product Total Quality Commitment**

All Distech Controls product lines are built to meet rigorous quality standards. Distech Controls is an ISO 9001 registered company. Distech Controls' products provide both the contractor and the end user with the flexibility of using "best-of-breed" products in system design.

## Available Sensor Models

	<b>SR65 AKF 62</b> <b>Wireless Air-Duct Temperature Sensor (62mm/2.4")</b> – 62mm/2.4" temperature sensor – Solar-powered (requires no battery)
	<b>SR65 AKF 135</b> <b>Wireless Air-Duct Temperature Sensor (135mm/5.3")</b> – 135mm/5.3" temperature sensor – Solar-powered (requires no battery)
	<b>SR65 AKF 192</b> <b>Wireless Air-Duct Temperature Sensor (192mm/7.6")</b> – 192mm/7.6" temperature sensor – Solar-powered (requires no battery)
	<b>SR65 AKF 240</b> <b>Wireless Air-Duct Temperature Sensor (240mm/9.4")</b> – 240mm/9.4" temperature sensor – Solar-powered (requires no battery)
	<b>SR65 AKF 320</b> <b>Wireless Air-Duct Temperature Sensor (320mm/12.6")</b> – 320mm/12.6" temperature sensor – Solar-powered (requires no battery)
	<b>SR65 AKF 465</b> <b>Wireless Air-Duct Temperature Sensor (465mm/18.3")</b> – 465mm/18.3" temperature sensor – Solar-powered (requires no battery)

## Selecting the Mounting Place for Solar Energy Storage

To meet special requirements concerning a correct and sufficient ambient brightness, you have to observe certain basic conditions, when selecting the mounting place.

By means of the energy-optimized EnOcean® radio technology used in our "EasySens" wireless sensors, supplying themselves with electric energy by a 2 cm<sup>2</sup> solar cell, the devices can work without batteries. Thanks to the cessation of changeable batteries the sensors are almost maintenance-free and environmentally sound.

If necessary, the solar-powered energy storage must be recharged after a longer storage of the radio sensors in darkness, e.g. during installation. In principle, however, this is made automatically during the first operating hours in daylight. If the initial charging should not be sufficient in the first operating hours, the sensor is reaching its full operating state after 3 to 4 days at the latest. The sensor is sending properly in darkness (in the night) after this period of time at the very latest.

When selecting the mounting place for the radio sensors, the following should be considered:

- The minimum illumination of 200lx should be guaranteed at the mounting place for at least 3 to 4 hours everyday regardless whether there is artificial light or daylight.

- The health and safety at work act requires a minimum illumination of 500lx for office workplaces.
- The illumination should not exceed 1000lx in the long term.
- A recess that is not illuminated sufficiently in the course of a day should be avoided.
- When using collimated artificial light the angle of incidence on the solar cell should be not too steep.
- The sensors should preferably be mounted with the solar cell in window direction, whereas a direct sun radiation should be avoided. An occasionally direct sun radiation would lead to falsified measuring values with the temperature detection.
- With regard to a future use of the room, the mounting place should be selected in that way, that a later shadowing by the user, e.g. by filing places or rolling containers, is avoided.

### What to do if the ambient brightness is not sufficient?

Depending on the application (dark rooms etc.) it is also possible to operate the device by a battery. Thus, the sensor is equipped with a corresponding battery holder. Battery to be used: Lithium battery 3.6V/1.1Ah Type LS14250 / 1/2AA, operating time approx. 5 to 10 years, depending on the intentional component aging and the self-discharge of the battery used. In order to change over the sensor from solar to battery operation, just put the battery into the battery holder.

### Transmitting Frequency

The sensors send event or time controlled telegrams to the receiver.

#### Measuring Principle and Production of Telegram

A: Event Controlled

By actuating the learning button of the device, the internal microprocessor is woken up, the measuring value for temperature is detected and a telegram to the receiver is generated.

B: Time Controlled

The internal microprocessor is woken up within a time interval of approx. 1.6 minutes (T\_wake up) and the measuring value for temperature is detected. If the status of an input has changed since the last inquiry (temperature change > 2% (>1.6°C), a telegram is produced immediately. If the input value temperature remain unchanged compared with the previous telegrams, a telegram is automatically produced at the latest after expiration of the fixed sending time of approx. 16 minutes (T\_send).

Information: Temperature value

Telegram-Production: Time controlled

After a telegram is sent, regardless whether produced by status changes or after expiration of T\_send, the times T\_wake up and T\_intervall are re-started.



A telegram includes all information (temperature value etc....)

#### Setting of Transmission Time

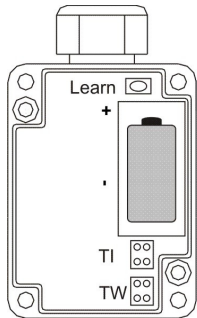

TW (Twake up)	TI (Tintervall)
=1	=1
=10	=10
=100	=100

#### Manufacturer's Adjustment

T\_wake up: 100, T\_intervall: 10

T\_send = 100sec. wake up x 10 interval = 1000sec. = approx. 16 Min.



The sending frequency has a direct influence on the operation energy available in the energy storage. Thus, it also affects the discharge time of the energy storage during running operation.

### Description Radio Telegram

ORG	7 dec. Always (EnOcean module type "4BS")
Data_byte1	Temperature 10...90°C, linear n=255...0
Data_byte0	Bit D3 Learn Button (0=Button pressed)
ID_Byte3	device identifier (Byte3)
ID_Byte2	device identifier (Byte2)
ID_Byte1	device identifier (Byte1)
ID_Byte0	device identifier (Byte0)

### Mounting Advice

The devices are supplied in an operational status. Probably, the internal solar energy storage must be recharged after a longer storage of the radio sensors in darkness. In principle, the recharging process is done automatically during the first operating hours in daylight. For this purpose, please refer to the remarks "solar energy storage".

Depending on the application, the cable temperature sensor is assembled to the air duct by means of a mounting flange respectively a clamp screw joint. Operation of the sensor with an immersion pocket: Use contact fluid for better heat transfer between sensor and measuring medium. When using our sensing elements in moist rooms or for purposes in refrigeration technique, we recommend our IP67 version "SI-Protection".

For an optimum location and receiving range, please see the "radio information" on the following pages.

### Installation

In order to assure a correct evaluation of the measuring values by the receiver, it is necessary to have the devices learned by the receiver. This is done automatically by means of a "learn button" at the sensor or manually by input of the 32bit sensor ID and a special "learning procedure" between sender and receiver. The respective details are described in the corresponding software documentation of the receiver.

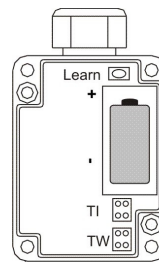

Learning-in of a telegram with button actuation

### Information on Wireless Sensors

#### Transmission Range

As the radio signals are electromagnetic waves, the signal is damped on its way from the sender to the receiver. That is to say, the electrical as well as the magnetic field strength is removed inversely proportional to the square of the distance between sender and receiver ( $E.H \sim 1/r^2$ ).

Beside these natural transmission range limits, further interferences have to be considered: Metallic parts, e.g. reinforcements in walls, metallized foils of thermal insulations or metallized heat-absorbing glass, are reflecting electromagnetic waves. Thus, a so-called radio shadow is built up behind these parts.

It is true that radio waves can penetrate walls, but thereby the damping attenuation is even more increased than by propagation in the free field.

Penetration of radio signals:

Material	Penetration
Wood, gypsum,	90...100%
glass uncoated	
Brick, pressboard	65...95%
Reinforced concrete	10...90%
Metal, aluminum pasting	0...10%

## Information on Wireless Sensors

### Transmission Range

As the radio signals are electromagnetic waves, the signal is damped on its way from the sender to the receiver. That is to say, the electrical as well as the magnetic field strength is removed inversely proportional to the square of the distance between sender and receiver ( $E, H \sim 1/r^2$ ).

Beside these natural transmission range limits, further interferences have to be considered: Metallic parts, e.g. reinforcements in walls, metalized foils of thermal insulations or metalized heat-absorbing glass, are reflecting electromagnetic waves. Thus, a so-called radio shadow is built up behind these parts.

It is true that radio waves can penetrate walls, but thereby the damping attenuation is even more increased than by propagation in the free field.

Penetration of radio signals:

Material	Penetration
Wood, gypsum, glass uncoated	90...100%
Brick, pressboard	65...95%
Reinforced concrete	10...90%
Metal, aluminum pasting	0...10%

For the practice, this means that the building material used in a building is of paramount importance for the evaluation of the transmitting range. For an evaluation of the environment, some guide values are listed:

Radio path range/-penetration:

Visual contacts: Typ. 30m range in passages, corridors, up to 100m in halls

Gypsum walls/wood: Typ. 30m range through max. 5 walls

Brick wall/Gas concrete: Typ. 20m range through max. 3 walls

Reinforced concrete/-ceilings: Typ. 10m range through max. 1 ceiling

Supply blocks and lift shafts should be seen as a compartmentalization

In addition, the angle with which the signal sent arrives at the wall is of great importance. Depending on the angle, the effective wall strength and thus the damping attenuation of the signal changes. If possible, the signals should run vertically through the walling. Walling recesses should be avoided.

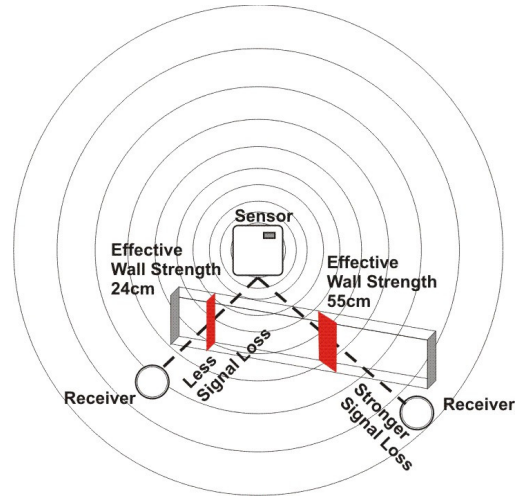
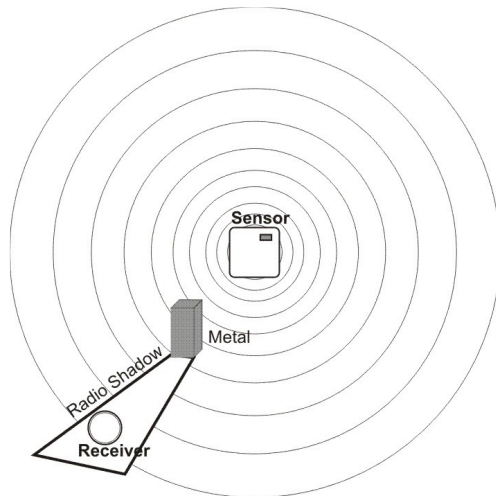

### Other Interference Sources

Devices that also operate with high-frequency signals, e.g. computer, audio-/video systems, electronic transformers and ballasts etc. are also considered as an interference source. The minimum distance to such devices should amount to 0,5m.

### Find the Device Positioning by Means of the Field Strength Measuring Instrument – EPM 100

EPM 100 is a mobile tool for measuring and indicating the received field strength (RSSI) of the EnOcean telegrams and disturbing radio activity at 868.3 MHz. It supports electrical installers during the planning phase and enables them to verify whether the installation of EnOcean transmitters and receivers is possible at the positions planned.

It can be used for the examination of interfered connections of devices, already installed in the building.

Proceeding for determination of mounting place for wireless sensor/ receiver:

Person 1 operates the wireless sensor and produces a radio telegram by key actuation

By means of the displayed values on the measuring instrument, person 2 examines the field strength received and determines the optimum installation place, thus.

### High-Frequency Emission of Wireless Sensors

Since the development of cordless telephones and the use of wireless systems in residential buildings, the influence of radio waves on people's health living and working in the building have been discussed intensively. Due to missing measuring results and long-term studies, very often great feelings of uncertainty have been existed with the supporters as well as with the critics of wireless systems.

A measuring expert's certificate of the institute for social ecological research and education (ECOLOG) has now confirmed that the high-frequency emissions of wireless keys and sensors based on EnOcean technology are considerably lower than comparable conventional keys.

Thus, it is good to know, that conventional keys do also send electromagnetic fields, due to the contact spark. The emitted power flux density ( $W/m^2$ ) is 100 times higher than with wireless sensors, considered over the total frequency range. In addition, a potential exposition by low-frequency magnet fields, emitted via the wires, is reduced due to wireless keys. If the radio emission is compared to other high-frequency sources in a building, such as DECT-telephones and basis stations, these systems are 1500 times higher-graded than wireless keys.

### Optional Accessories

THMS	Immersion pocket, mat. Brass nickel-plated, safe up to 16bar
THVA	Immersion pocket, mat. Brass nickel-plated, safe up to 40bar
MF7	Mounting flange
LS14250	Battery Easy Sens (1.1Ah, 3.6V, .5AA). For optional use as a battery-powered sensor.

## Product Specifications

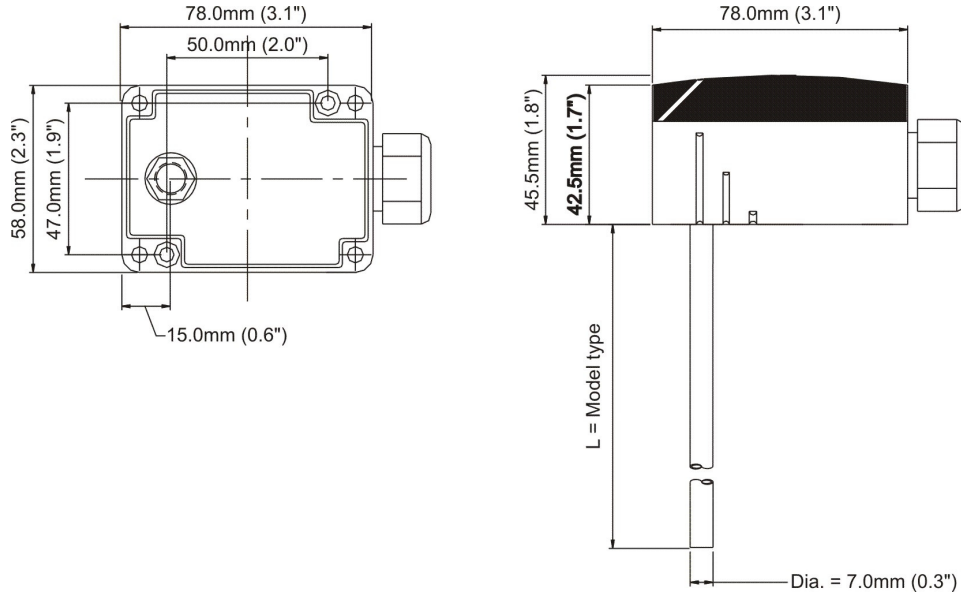

Power		Features	
Energy Generator:	Solar cell, internal goldcap, maintenance-free	Temperature Detection:	Range: 10°C to 90°C; 50°F to 194°F
Protection:	IP65 according to EN60529		Resolution: 0.31K
Optional Battery:	Lithium 3.6V/1.1Ah; Type LS14250; 1/2AA		Absolute Accuracy: typ. ± 0.8K
	Approx. 5-10 year operating time depending on intentional component aging and self discharge	<b>Electromagnetic Compatibility</b>	
<b>Environmental</b>		CE -Conformity:	89/336/EWG Electromagnetic compatibility
Operating Temperature:	-25°C to 65°C; -13°F to 149°F		R&TTE 1999/5/EC Radio and Telecommunications Terminal Equipment Directive
Storage Temperature:	-25°C to 65°C; -13°F to 149°F	Standards:	ETSI EN 301 489-1: 2001-09
Relative Humidity:	0 to 70% Non-condensing		ETSI EN 301 489-3: 2001-11
<b>General</b>			ETSI EN 61000-6-2: 2002-08
Technology:	EnOcean, STM	FCC:	ETSI EN 300 220-3: 2000-09
Transmitting Frequency:	868.3 MHz		ID: S3N-SRXX
Approx. Transmitting Range:	30m / 98.4' in buildings, 300m / 984.3' in free propagation		This device complies with Part 15 of the FCC rules
Measuring Value Detection:	Every 100 seconds		
Sending Interval:			
...every 100 seconds	with changes > 1.6K		
...every 1000 seconds	with changes < 1.6K		
<b>Enclosure</b>			
Material (Bottom part):	PA6 (ASA)		
Color:	White		
Material (Top Cover):	PC		
Color:	Crystal clear		
Sensor bushing:	Stainless steel grade 1.4571 ; Dia. = 7mm / 0.3"		
Mounting Lengths:	62mm / 135mm / 192mm / 240mm / 320mm/ 465mm 2.4" / 5.3" / 7.6" / 9.4" / 12.6" / 18.3"		
Dimensions overall:	58.0mm x 78.0mm x 45.5mm (2.3" x 3.1" x 1.8")		
Shipping Weight:	0.14kg (0.31lbs)		



- The general registration for the radio operation is valid for all EU-countries as well as for Switzerland.
- Operation is subject to the following two conditions:
  - This device may not cause harmful interference
  - This device must accept any interference received, including interference that may cause undesired operation.



- Changes or modifications made to this equipment not expressly approved by Distech Controls may void the FCC authorization to operate this equipment.
- The installation and assembly of electrical equipment may only be performed by a skilled electrician.
- The modules must not be used in any relation with equipment that supports, directly or indirectly, human health or life or with applications that can result in danger for people, animals or real value.

### Specifications subject to change without notice.

Distech Controls logo is a trademark of Distech Controls Inc.; LONMARK is a registered trademark of Echelon Corporation.  
Niagara<sup>AX</sup> Framework is a trademark of Tridium, Inc. EnOcean is a registered trademark of EnOcean GmbH.



05DI-DSSR65A-11

## SR65 AKF Series

Distech Controls, Inc.  
Tel. toll-free North America: 1-800-404-0043  
Tel. international: 1-450-444-9898  
www.distech-controls.com  
sales@distech-controls.com